

**3/8" & 7/16" Herreshoff Bronze Shell Blocks  
3/8" to 3/4" Herreshoff Special "Short" Blocks**

**Double and Cheek blocks available**

*NOTE: Line capacity is 1/16" less than block size.*

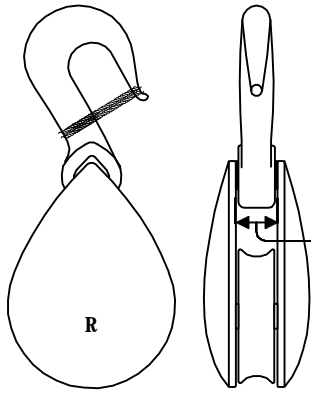

**Plain Hook**

3/8" Block; 4217 + 4216 (3.8 oz.) **\$66**  
7/16" Block; 4750 + 4751 (6.0 oz.) **\$76**

*Use with flange eyes for halyards and sheets.*

**SIZE MEASURED HERE**  
3/8" blocks, use 5/16" line  
7/16" blocks, use 3/8" line

*Blocks shown with lacing can be "moused" for security.*

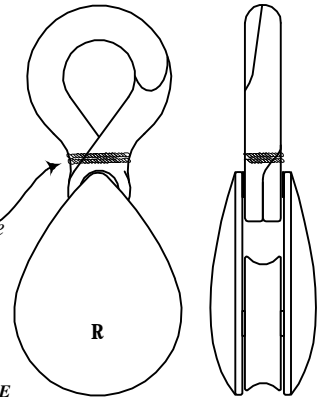

**Sister Hook**

3/8" Block; 4217 + 5641 (4.5 oz.) **\$73**  
7/16" Block; 4750 + 12160 (6.5 oz.) **\$84**

*Use for headsail halyards and sheets.*

**SIZE MEASURED HERE**  
(3/8" block shown  
1/2 actual size)



**Special "Short" Blocks**

*Spliced directly to line for Jib lead blocks, Lazy jacks, etc.*

- 3/8" Block, 8093; 8095 Link (optional) (1.9 oz.) **\$ 45**
- 7/16" Block, 7219; 7896 Link (optional) (2.9 oz.) **\$ 50**
- 1/2" Block, 12224; 3127½ Link (optional) (9.1 oz.) **\$ 60**
- 5/8" Block, 7221; 7221½ Link (optional) (12.9 oz.) **\$ 80**
- 3/4" Block, 7568; 7568½ Link (optional) (TBD) **\$ 120**

These blocks have Delrin sleeve bearings.

Use Link to change from front to side splice.

Other attachments are available for these blocks. Please Inquire.

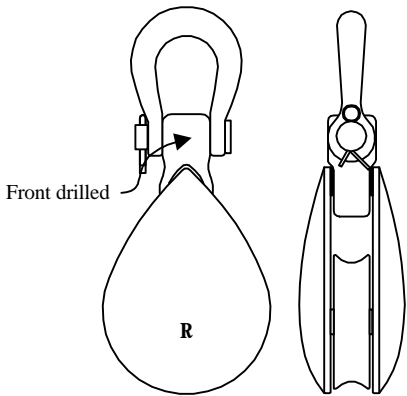

**Shackle Link & Shackle**

**Single & Double**

*Please Specify Front or Cross drilled.* **Sgl. Dbl.**

3/8" Block; 4217 + 3377½ Front (4.6 oz.) **\$77 \$150**

7/16" Block; 4750 + 3377¼ Front (6.8 oz.) **\$87 \$165**

Shackle; P/Ns; 0002 (3/8"), 0001 (7/16") (included)

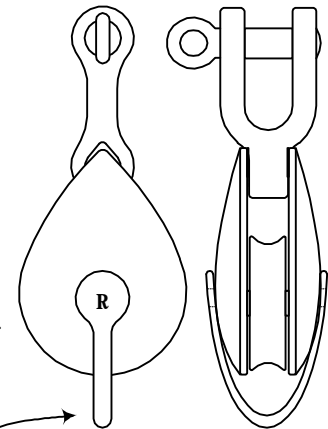

**Upset Shackle**

3/8" Block; 4217 + 4732 (4.0 oz.) **\$75**

7/16" Block; 4750 + 4752 (5.9 oz.) **\$85**

*Attach to wire splices for backsays etc.*

**Beckets** are available for all blocks on this page. Please specify when ordering.

3/8" shell Blocks; add P/N 4773 **\$17**

7/16" shell Blocks; add P/N 4757½ **\$17**

(for short blocks, please inquire)

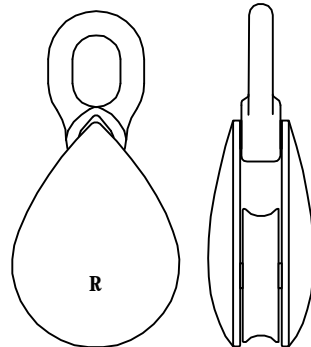

**Traveler Link**

3/8" Block; 4217 + 4219 (3.6 oz.) **\$66**

7/16" Block; 4750 + 4757 (5.1 oz.) **\$76**

*Use on traveler bar or mounted with deck bow.*

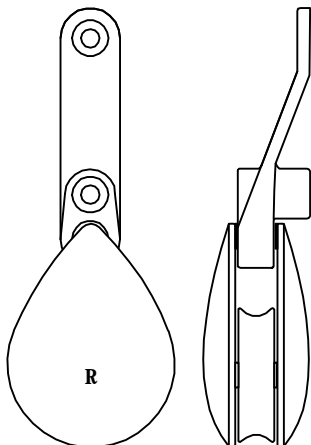

**Throat Hanging**

3/8" Block; 4217 + 4213 (4.2 oz.) **\$70**

7/16" Block; 4750 + 4755 (5.8 oz.) **\$80**

*Mounts directly to mast. Used singly, with a becket or in pairs as needed.*

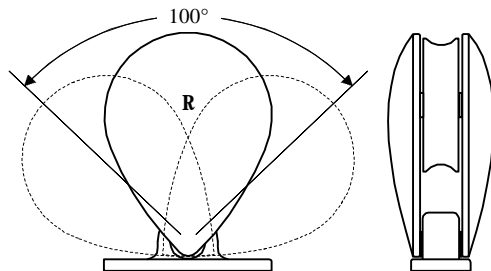

**Halyard Lead Block**

**Single & Double**

3/8" Block; 4217 + 4214 (3.4 oz.) **\$70 \$122**

7/16" Block; 4750 + 4754 (5.2 oz.) **\$80 \$135**

*Use for halyard leads at base of mast, etc.*

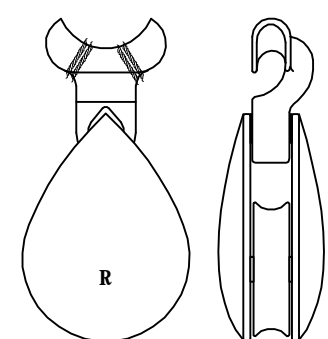

**Span Hook**

3/8" Block; 4217 + 6758 (3.5 oz.) **\$66**

7/16" Block; 4750 + 5540 (5.3 oz.) **\$76**

**Gaff Saddle**; for 3/16" & 1/4" wire

*For wire spans. Mouse to secure as shown.*

## 1/2", 5/8" & 3/4" Herreshoff Bronze Shell Blocks Triple and Cheek Blocks available

*NOTE: Line capacity is 1/16" less than block size.*

**SIZE MEASURED HERE**

1/2" blocks, use 7/16" line  
5/8" blocks, use 9/16" line  
3/4" blocks, use 11/16" line

Blocks shown with lacing can be "moused" for security.

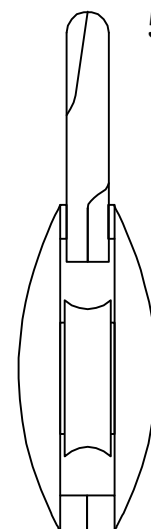
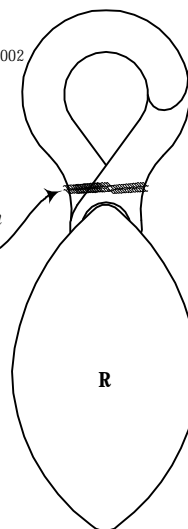
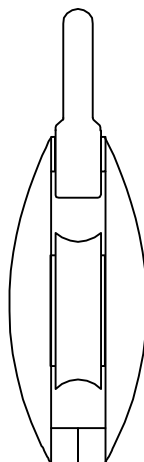
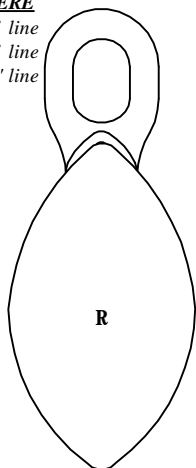
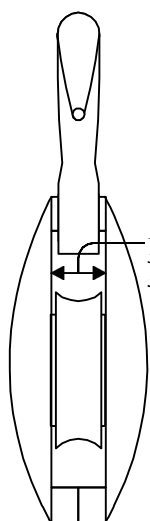
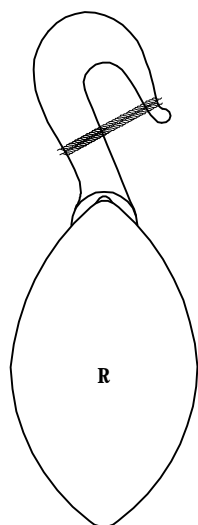

### Plain Hook

1/2" Blocks; Part No. 3370 + 3375 **\$ 95**  
5/8" Blocks; Part No. 3185 + 3187 **\$122**  
3/4" Blocks; Part No. 3176 + 3178 **\$170**  
*Use with flange eyes for halyards and sheets.*

### Sister Hook

1/2" Blocks; Part No. 3370 + 5627 **\$ 110**  
5/8" Blocks; Part No. 3185 + 5625 **\$140**  
3/4" Blocks; Part No. 3176 + 5605 **\$185**  
*Use for headsail halyards and sheets.*

### Traveler Link

1/2" Blocks; Part No. 3370 + 4734 **\$ 95**  
5/8" Blocks; Part No. 3185 + 4737 **\$122**  
3/4" Blocks; Part No. 3176 + 4776 **\$170**  
*Use on travelers and with deck bows.*

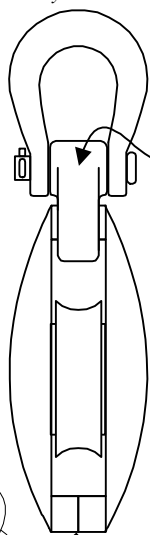
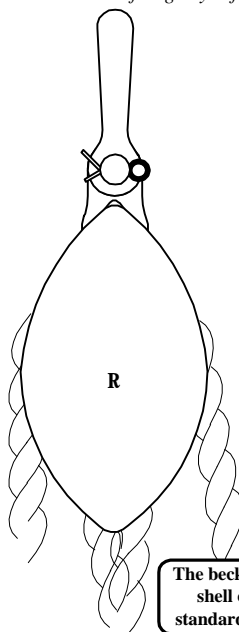

Cross drilled

### Shackle Link & Shackle

*Please specify Front or Cross drilled*

#### Singles

1/2" Blocks; Part No. 3370 + (3377 Front or 3379 Cross) **\$122**  
5/8" Blocks; Part No. 3185 + (3187½ Front or 3188½ Cross) **\$155**  
3/4" Blocks; Part No. 3176 + (3183 Front or 3184 Cross) **\$210**  
Shackle, D; Part No. 5647 (5/8"), 7895 (3/4") **(w/Shackle)**  
Shackle, Bow; Part No. 3376 (1/2"), 3186½ (5/8"), 3182 (3/4")

#### Doubles

1/2" Blocks; Part No. 3371 + (10659 Front or 10658 Cross) **\$190**  
5/8" Blocks; Part No. 3189 + (3191½ Front or 8428 Cross) **\$245**  
3/4" Blocks; Part No. 3181 + (3183½ Front or 6242 Cross) **\$325**  
Shackle, D; Part No. 5647 (1/2"), 7895 (5/8"), 7894 (3/4") **(w/Shackle)**  
Shackle Bow: Part No. 3186½ (1/2"), 3182 (5/8"), 3363 (3/4")

The becket is an integral part of the shell castings and is therefore standard on all blocks on this page.

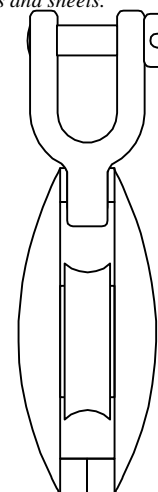
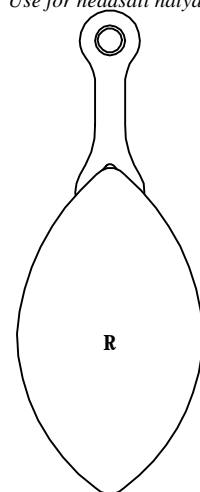

### Upset Shackle

1/2" Blocks; Part No. 3370 + 4738 **\$115**  
5/8" Blocks; Part No. 3185 + 4738 **\$145**  
3/4" Blocks; Part No. 3176 + 4775 **\$190**  
*Attach to wire splices for backsays etc.*

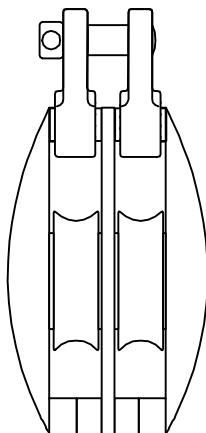
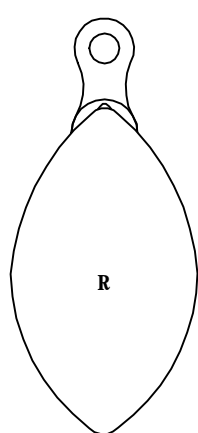

### Davit Shackle, Double

1/2" Blocks; Part No. 3371 + 3383 **\$180**  
5/8" Blocks; Part No. 3189 + 3191 **\$245**  
3/4" Blocks; Part No. 3181 + 3181½ **\$315**  
*Use for throat halyards and boackstay.*

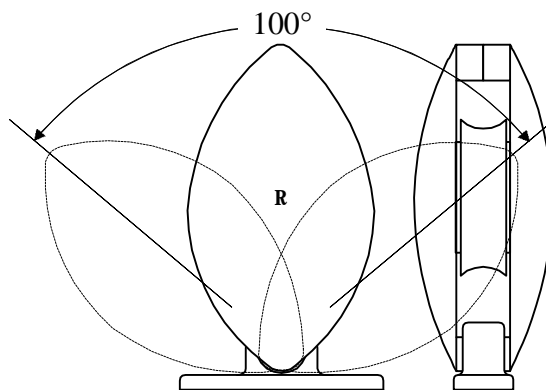

### Halyard Lead Block, Single & Double

	<b>Single</b>	<b>Double</b>
1/2" Blocks; Part No. 3370 Single or 3371 Double + 3382	<b>\$100</b>	<b>\$180</b>
5/8" Blocks; Part No. 3185 Single or 3189 Double + 3190	<b>\$130</b>	<b>\$240</b>
3/4" Blocks; Part No. 3176 Single or 3181 Double + 3180½	<b>\$175</b>	<b>\$305</b>

*Use for halyard leads at base of mast, etc.*

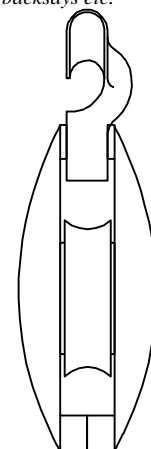
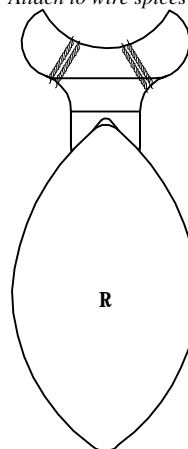

### Span Hook

1/2" Blocks; Part No. 3370 + 5539 **\$100**  
5/8" Blocks; Part No. 3185 + 5533 **\$130**  
3/4" Blocks; Part No. 3176, 5530, 5530½ **\$225**  
*3/4" span hook has keeper with leather thong.*

All parts on this page are burnished unless otherwise noted. Add 50% for polishing.

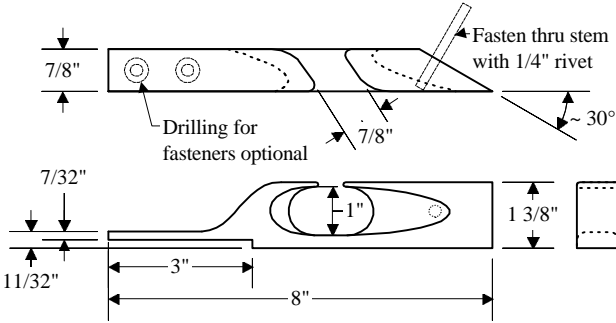

### Herreshoff style Bow Chock (Pr.)

Herreshoff Fish & Buzzards Bay 15; P/N 5637 & 5638 \$ 105  
 Herreshoff & Haven 12½ (not shown); P/N 4763 & 4764 \$ 95  
 Rozinante bow & stern, set from LHF patterns \$ 220  
 (unmachined) Others sizes available, please call.

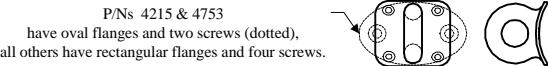

P/Ns 4215 & 4753  
 have oval flanges and two screws (dotted),  
 all others have rectangular flanges and four screws.

### Flange Eyes, Spar Mount

- 2" dia. spar, for 3/8" blocks; P/N 4215 \$ 25
- 2 1/2" dia. spar, for 7/16" blocks; P/N 4753 \$ 25
- 2 3/4" dia. spar, for 1/2" blocks; P/N 3380 \$ 30
- 3" dia. spar, for 5/8" blocks; P/N 3189½ \$ 45
- 3 3/4" dia. spar, for 3/4" blocks; P/N 3177½ \$ 75
- 5 1/4" dia. spar, for 1/2" blocks; P/N 7710 \$ 28
- 6 1/4" dia. spar, for 5/8" blocks; P/N 7822 \$ 45
- 7 1/4" dia. spar, for 3/4" blocks; P/N 7709 \$ 75

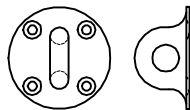

### Flange Eyes, Deck Mount

- 1 3/4" dia.; for 3/8" blocks; P/N 5661 \$ 20
- 2 1/8" dia.; for 7/16" blocks; P/N 5660 \$ 25
- 2 1/2" dia.; for 1/2" blocks; P/N 3381 \$ 30
- 3" dia.; for 5/8" blocks; P/N 3190½ \$ 45
- 3 3/4" dia.; for 3/4" blocks; P/N 3178½ \$ 75

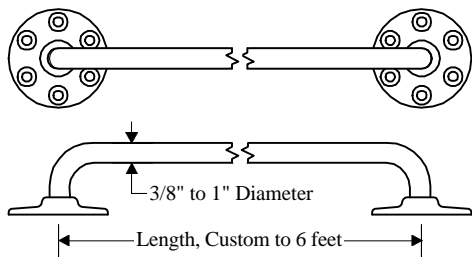

### Traditional Rod Traveler Assembly

3/8" Dia. rod for 2 1/8" Dia. Flange P/N 1227 \$ 110  
 7/16" Dia. rod for 2 1/8" or 2 3/8" Dia. Flange P/N 1228 \$ 120  
 1/2" Dia. rod for 2 3/8" or 2 5/8" Dia. Flange P/N 1229 \$ 155  
 5/8" Dia. rod for 2 5/8" or 3" Dia. Flange P/N 1233 \$ 195  
 3/4" Dia. rod for 4" Dia. Flange P/N 1232 \$ 250  
 Larger sizes available. Please call.

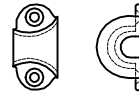

### Fair Lead

1/2" Eye; P/N 5657 \$ 23  
 5/8" Eye; P/N 1001 \$ 28

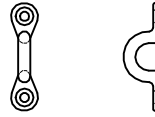

### Deck Bows

Block Series	P/N	
3/8"	5659	\$ 15
7/16"	5729	\$ 15
1/2"	5658	\$ 18
5/8"	5728	\$ 22
3/4"	5652	\$ 35

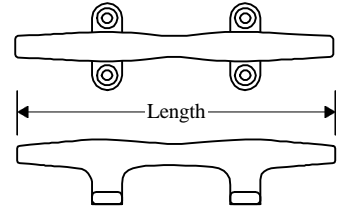

### Herreshoff Cleats

Length	Max. Line dia.		P/N	
4 1/8"	9/32" (7mm)		5546	\$ 30
5 1/8"	5/16" (8mm)		5544	\$ 40
6 5/8"	7/16" (11mm)		4758	\$ 55
7 3/4"	1/2" (13mm)		4697	\$ 75
9 5/8"	13/16" (21mm)		3347	\$ 110
12"	1" (25mm)		3323	\$ 145

Solid (Special drilling available)

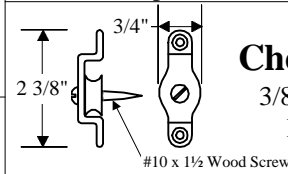

### Cheek Block

3/8" line Max.  
 P/N 1009 \$ 30

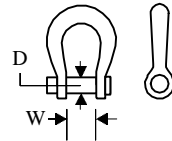

### Bow Shackles

W	D	P/N	
7/16	3/16	002	\$ 12
1/2	1/4	0001	\$ 14
9/16	1/4	3376	\$ 22
5/8	5/16	3186½	\$ 28
3/4	3/8	3182	\$ 38
7/8	7/16	3363	\$ 54

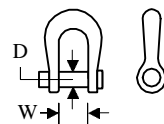

### D Shackles

W	D	P/N	
5/8	5/16	5647	\$ 28
3/4	3/8	7895	\$ 38
7/8	7/16	7894	\$ 54

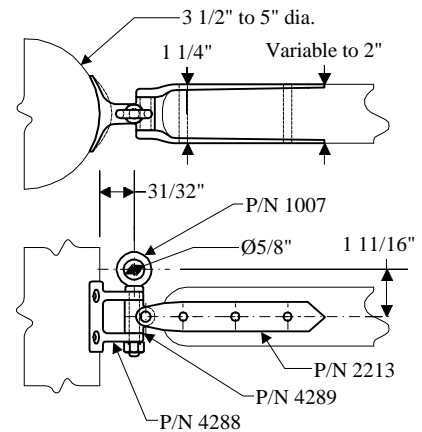

### Gooseneck Assembly (Boom Hanging) \$ 150

P/Ns 4288, 4289, 2213 (Pr.) & 1007  
 Also available; mast band gooseneck similar to above for 8" round mast. \$ 560

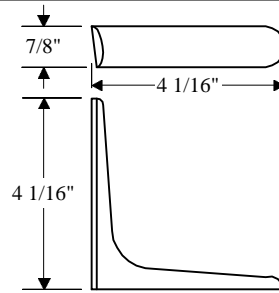

### Coaming Knees (Pr.)

P/N 7898 & 7899 \$ 95



### Jam Cleats

3" For 1/4" Line; P/N 1002 \$ 30  
 4" For 5/16" Line; P/N 1003 \$ 35  
 5" For 7/16" Line; P/N 1004 \$ 40

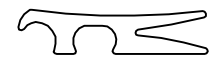

### Thumb Jam Cleats

3 1/4" For 3/8" Line; P/N 1005 \$ 30  
 3 7/8" For 7/16" Line; P/N 1006 \$ 35